

SS435FO4 Temperature sensor (1-port Resonator)

This product is lead-free in compliance with RoHS 2002/95/EC.

Typical performance: S11 @ 23°C

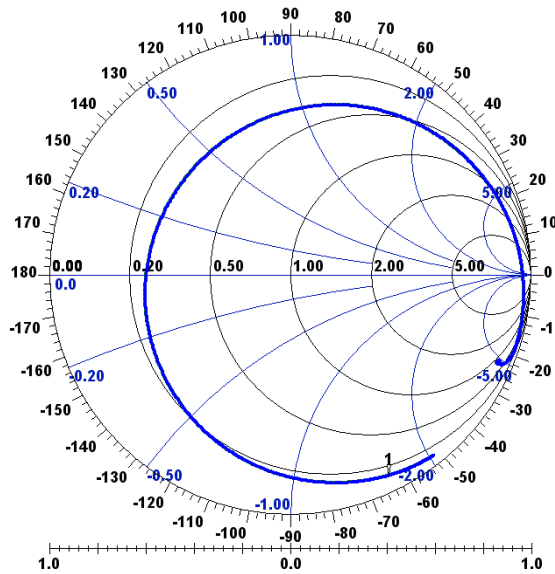

Test Conditions:

RF power	-10 dBm
Temperature	23.0 °C
DC Voltage	0 V
Terminating source impedance (Z_S):	50 Ω
Terminating load impedance (Z_L):	50 Ω

		min	typical	max	unit
Nominal frequency ^{*1}	F_n	435.270	435.285	435.300	MHz
Unloaded quality factor	Q_U	8000	11000		
Ageing @350°C				+2.0	K/1000h
Equivalent Circuit elements					
Motional capacitance	C_1		4.44		fF
Motional inductance	L_1		30.1163		μ H
Motional resistance	R_1		7.5		Ω
serial resistance	R_0		5		Ω
Parallel capacitance	C_0		2.3		pF
Operating temperature range		-40		350	°C
Temperature coefficient of frequency	TC_F				
	α		-0.034		ppm/K ²
	β		-40.4		ppm/K
	δ		911.0		ppm

Electrostatic Sensitive Device

^{*1} Nominal frequency is defined minimum s11

Temperature coefficient of frequency

$$\Delta F/F_n = \alpha \cdot T^2 + \beta \cdot T + \delta \text{ with } T \text{ in } ^\circ\text{C}$$

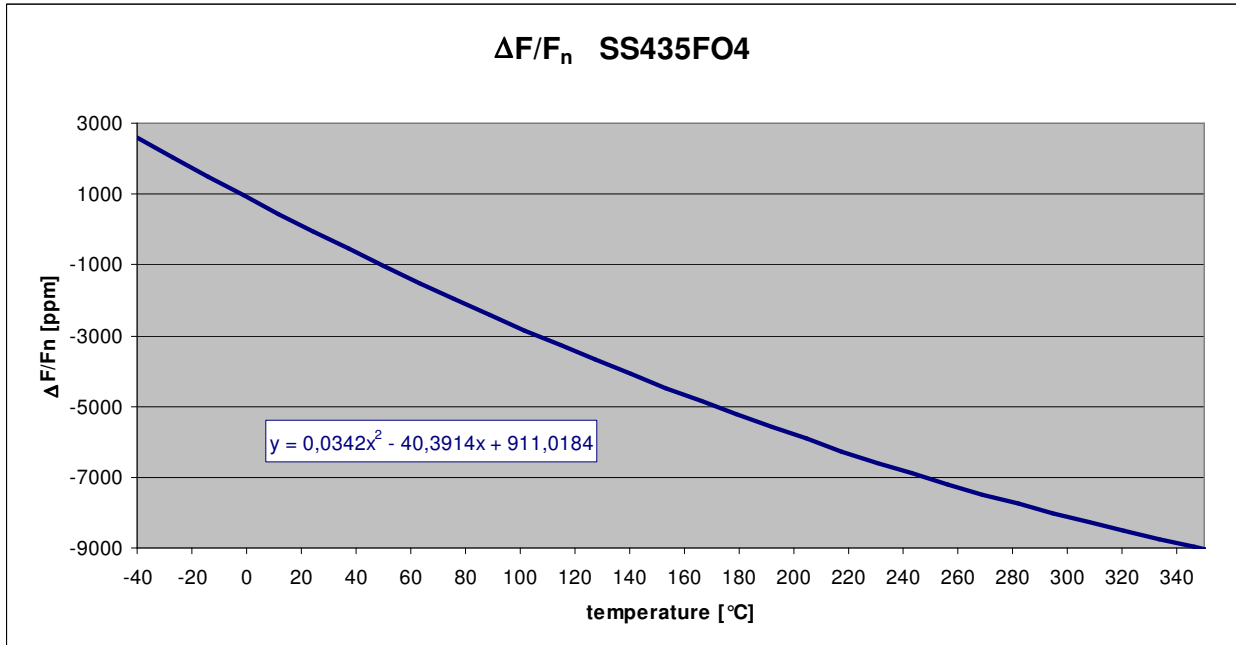

ageing

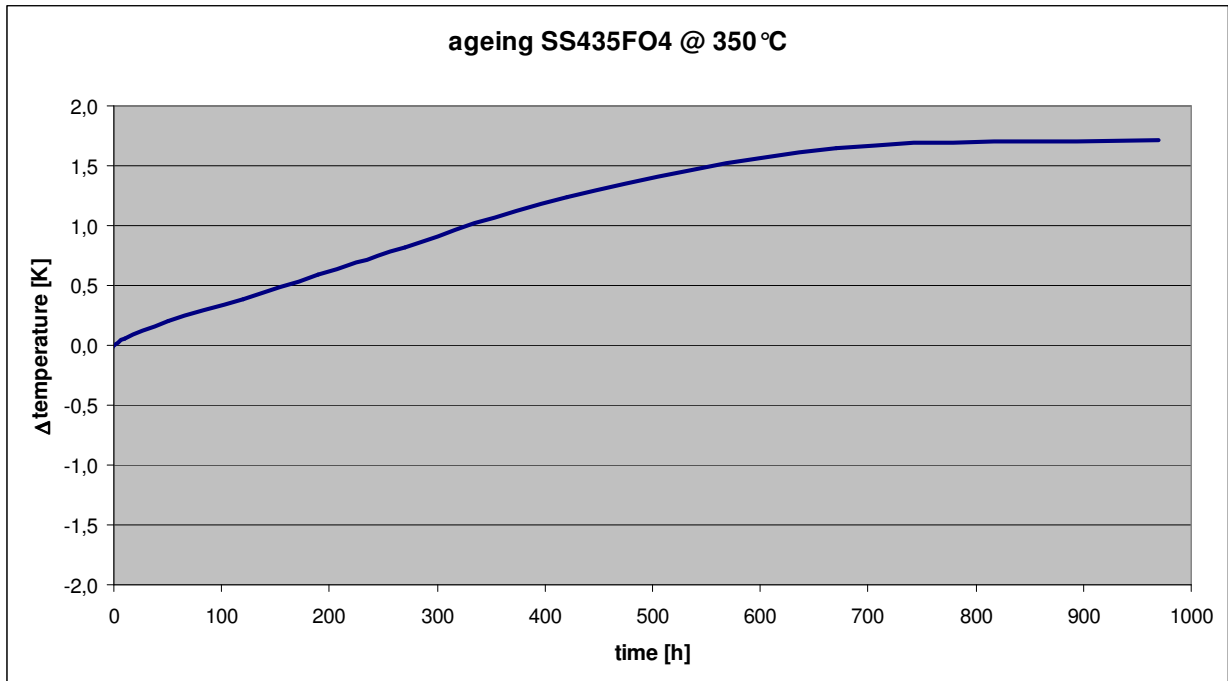

Typical performance:

Magnitude:

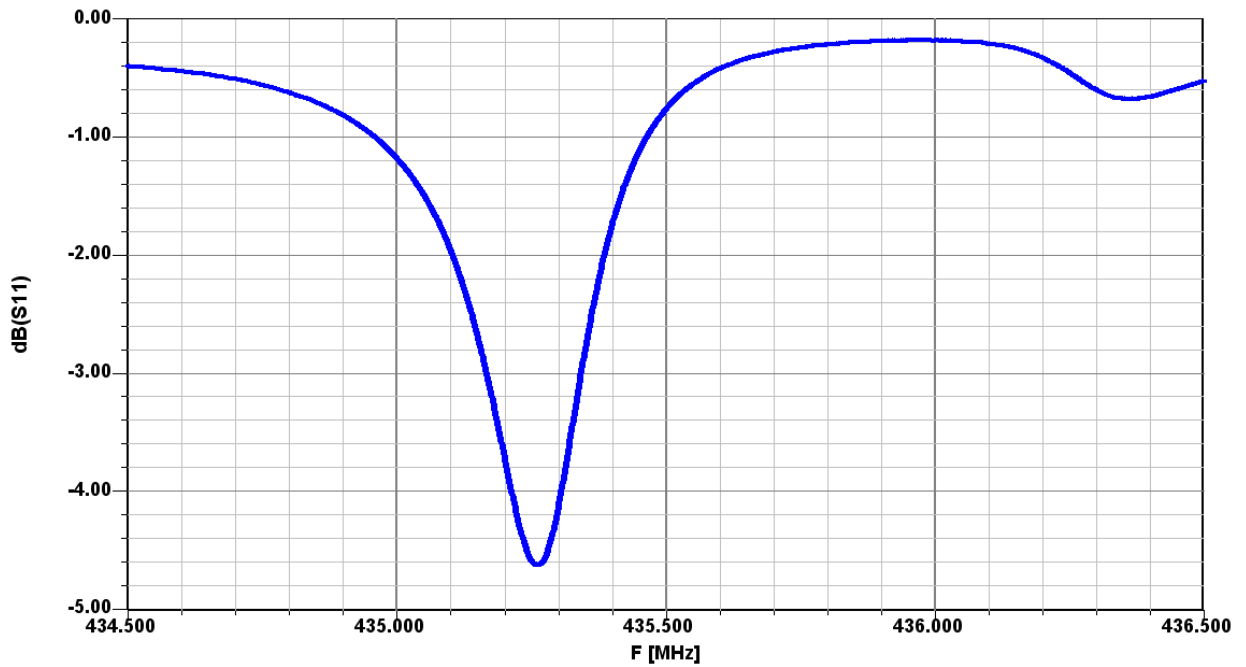

Admittance :

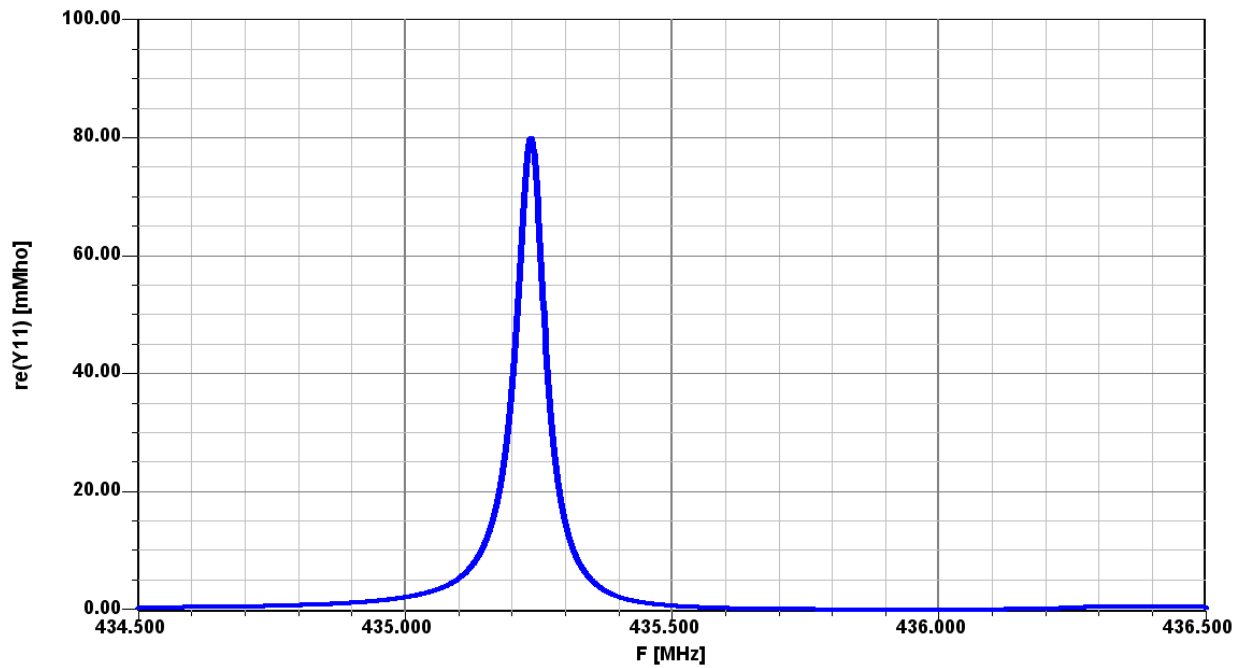

Equivalent Circuit

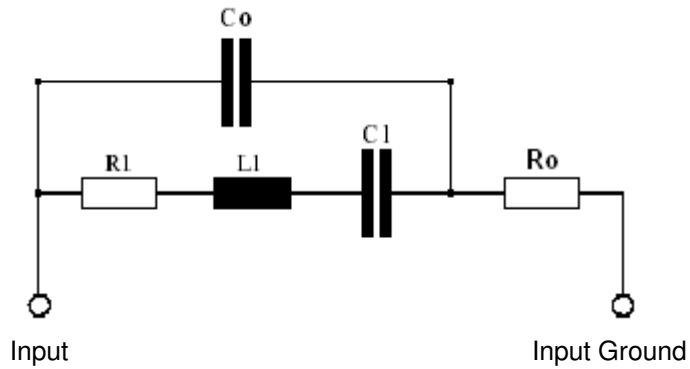

Package: TO25 / \varnothing 2.0mm

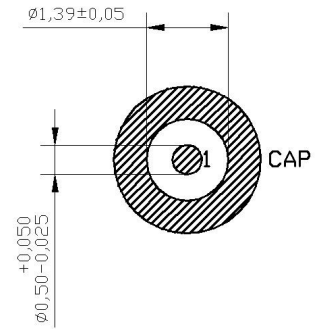
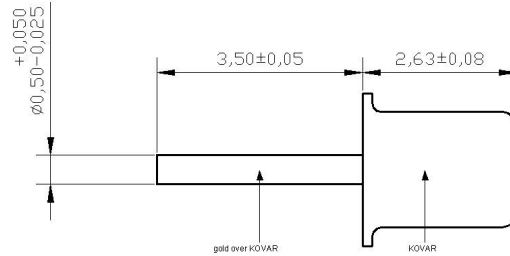
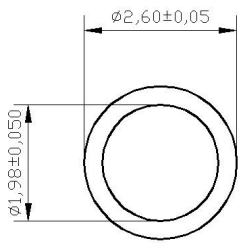

All dimensions in mm

Pin 1 Antenna (Input)
 Cap Ground