

SS2452BB2 Temperature sensor (1-port Resonator)

This product is lead-free in compliance with RoHS 2011/65/EU.

Typical performance: S11 @ 23°C

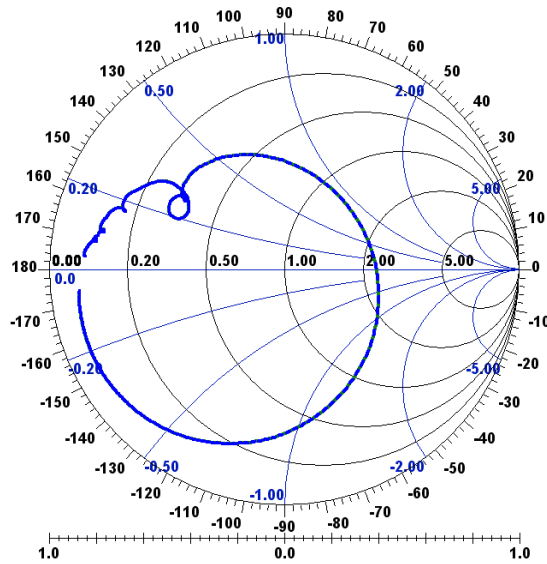

Test Conditions:

RF power	-10 dBm
Temperature	23.0 °C
DC Voltage	0 V
Terminating source impedance (Z_S):	50 Ω
Terminating load impedance (Z_L):	50 Ω

		min	typical	max	unit
Nominal frequency ^{*1}	F_n	2451.26	2451.96	2452.66	MHz
Unloaded quality factor	Q_U	7000	8750		
Ageing @200°C				-0.5	K/1000h
Equivalent Circuit elements					
Motional capacitance	C_1		7.212		fF
Motional inductance	L_1		583.78		nH
Motional resistance	R_1		1.03		Ω
serial resistance	R_0		2.8		Ω
Parallel capacitance	C_0		0.685		pF
Operating temperature range		-40		200	°C
Temperature coefficient of frequency	TC_F				
	α		-0.101		ppm/K ²
	β		-18.86		ppm/K
	δ		486.8		ppm

Electrostatic Sensitive Device

^{*1} Nominal frequency is defined as maximum impedance.

Temperature coefficient of frequency

$$\Delta F/F_n = \alpha \cdot T^2 + \beta \cdot T + \delta \text{ with } T \text{ in } ^\circ\text{C}$$

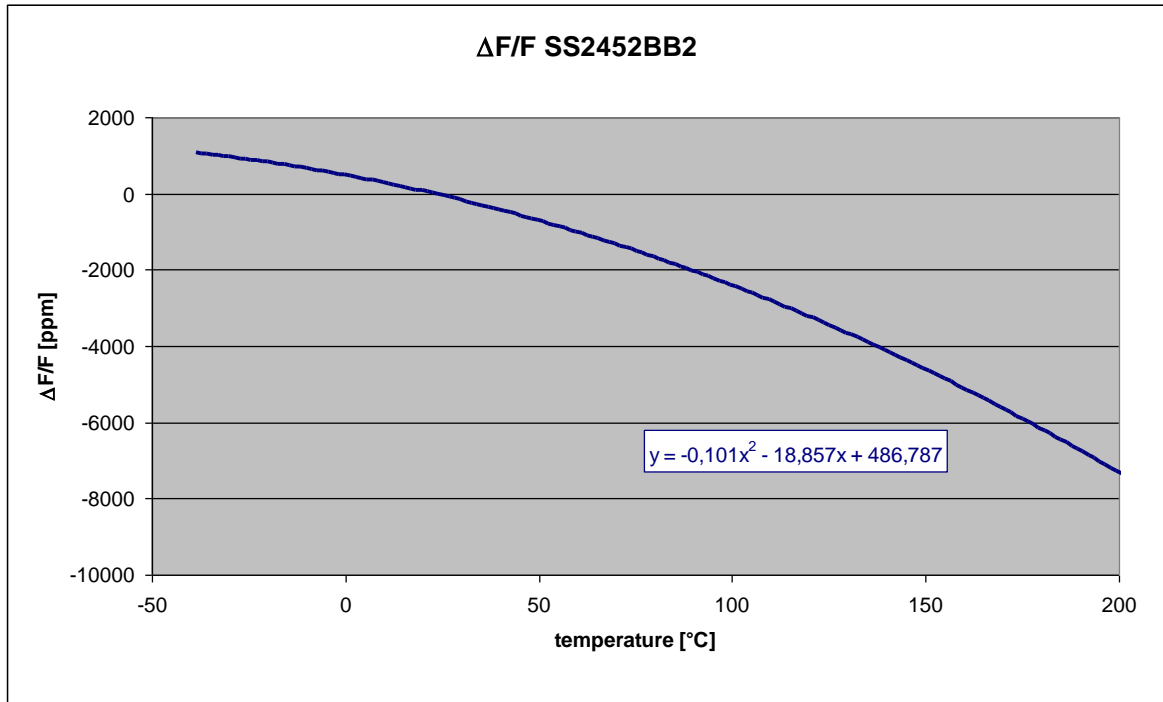

ageing

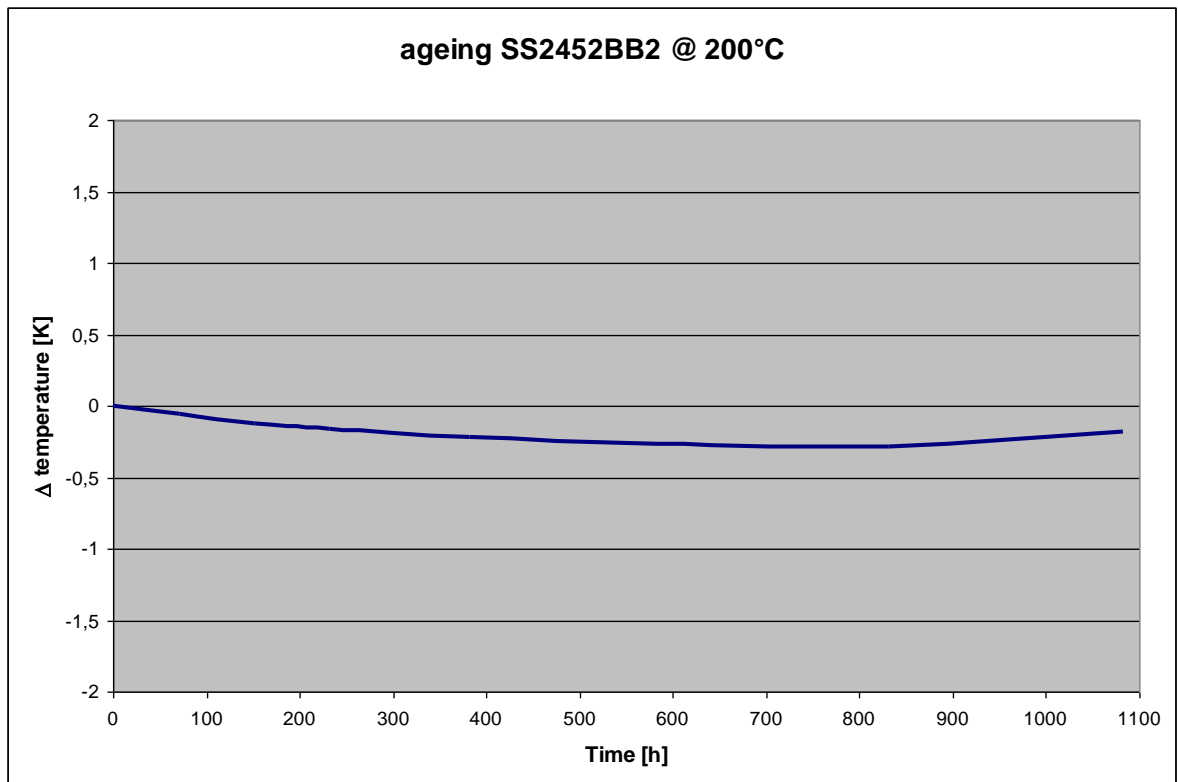

Typical performance:

Magnitude:

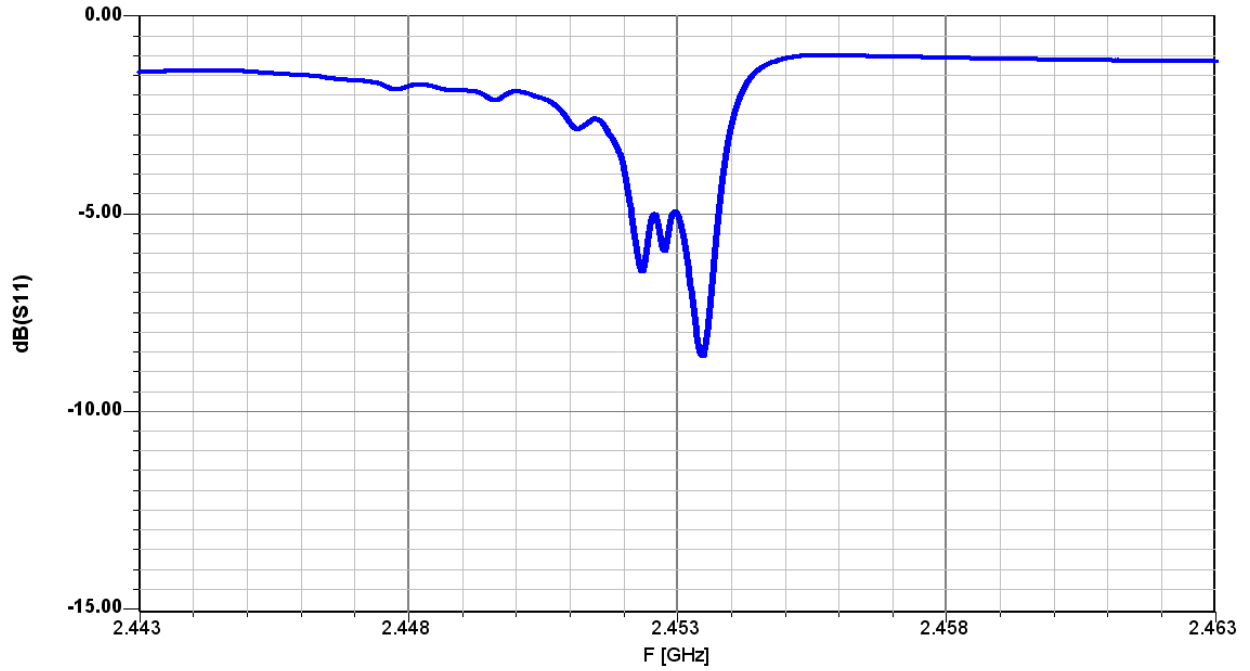

Impedance :

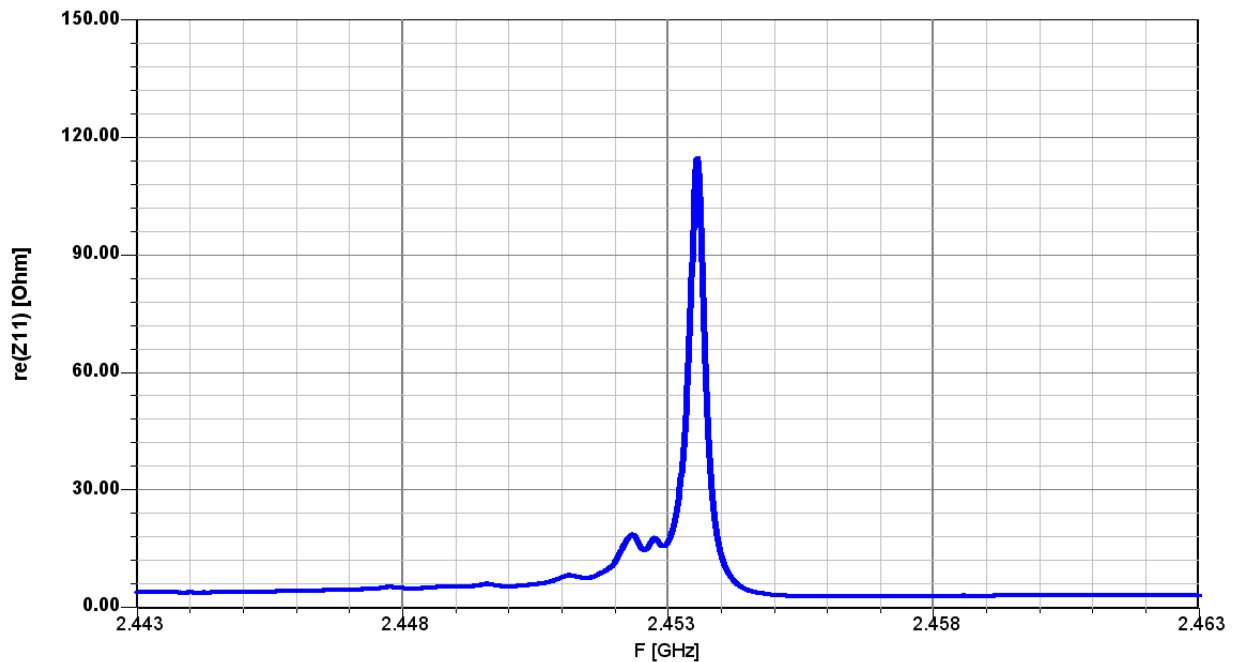

Equivalent Circuit

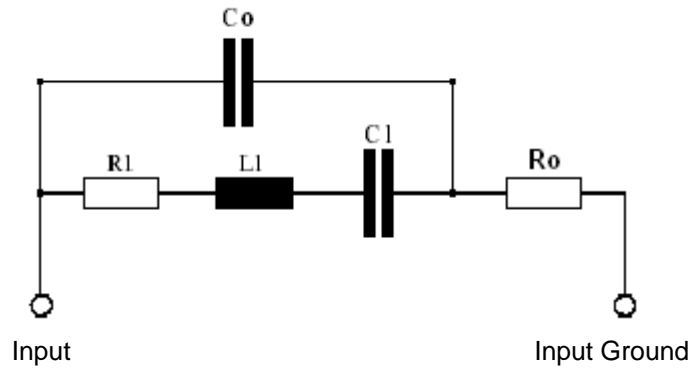

Package: S25 / 3.0*3.0mm²

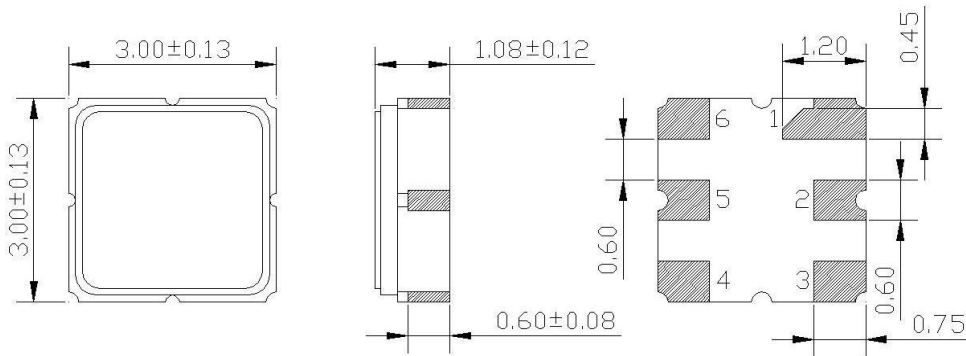

All dimensions in mm

Pin 1	Case ground	Pin 6	not connected
Pin 2	Antenna (Input/Ground)	Pin 5	Antenna (Ground/Input)
Pin 3	not connected	Pin 4	Case ground

Marking

S...	Type
XXZZLL	Date code
XX	Year
ZZ	Calendar week
LL	Lot Number

